

REVISION HISTORY	
1	Original Part

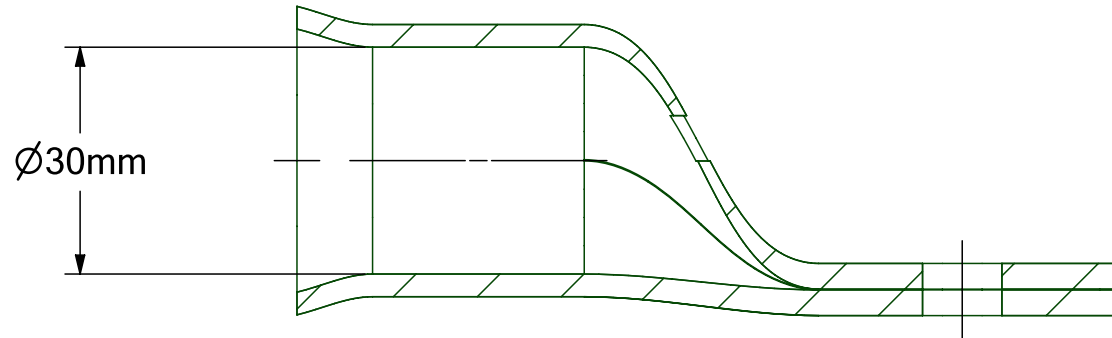

SECTION A-A

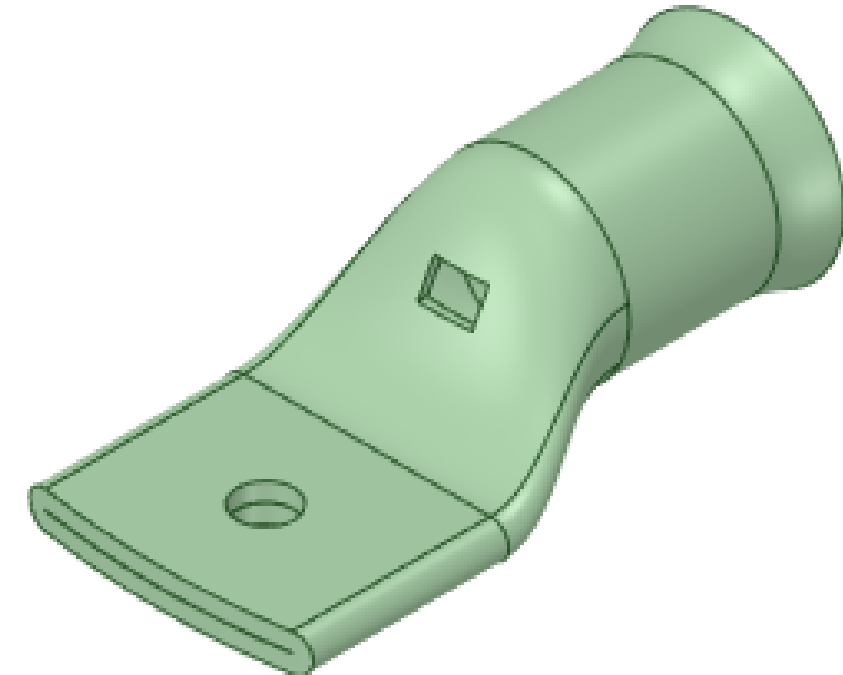
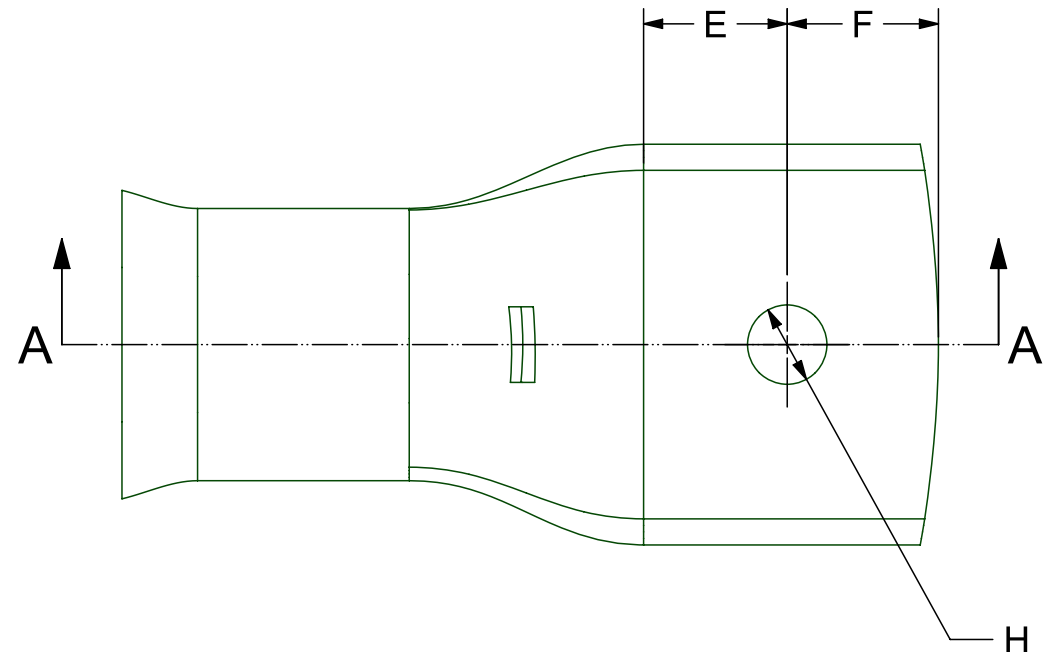
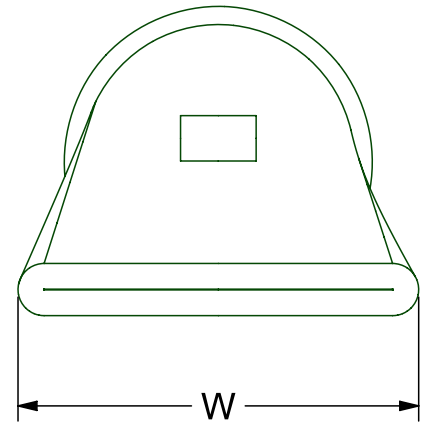

PART NO.	H (mm)	E (mm)	F (mm)	W (mm)
TCSD-500-0	0	N/A	40.0	53.0
TCSD-500-6	6.5	20.0	20.0	53.0
TCSD-500-8	8.5	20.0	20.0	53.0
TCSD-500-10	10.5	20.0	20.0	53.0
TCSD-500-12	13.0	20.0	20.0	53.0
TCSD-500-14	14.5	20.0	20.0	53.0
TCSD-500-16	16.5	20.0	20.0	53.0

UOS - LINEAR TOLERANCE PERMISSABLE DEVIATIONS FOR SIZE RANGE:
Tolerances according to DIN ISO 2768 (V)

DIMS IN MM	0.5 to 3	>3 to 6	>6 to 30	>30 to 120	>120 to 400	>400 to 1000	>1000 to 2000	>2000 to 4000
	-	±0.5	±1.0	±1.5	±2.5	±4.0	±6.0	±8.0



Total Connections 2009 LTD

www.tc2009.co.uk
sales@tc2009.co.uk
Tel 01249 812 707

Drawing No. TCDR1945

Material. CW024A (C106)
COPPER

Part No. TCSD-500-RANGE

Finish. 5MICRON ELECTRO
TIN PLATED

SIZE A3
Date 08/06/2021

Created By:
Dan Hewlett

REV 1

SCALE 1:1

SHEET 1 of 1